



# HEALTHFLO<sup>®</sup>

AUTOMATIC FAUCET SYSTEMS

Model  
AEF-300-SMHF



## Description

Sensor Operated, Gear Motor Driven, Chrome Plated Brass Automatic Faucet System For Tempered or Hot/Cold Water Operation For Healthcare Facilities

## Flow Rate

- 1.5 gpm/5.7 Lpm Laminar
- 2.2 gpm/8.3 Lpm Laminar

## Specifications

- Chrome Plated Solid Brass Spout (Standard)
- Less Than 0.25% Lead Content by Weighted Average
- Patented BRV<sup>®</sup> and Gear Motor Drive
- Hands Free Infrared Sensor Activation
- Powered by Four (4) C-Cell Batteries (Included)
- Easy Battery Replacement - No Water Shut Off Necessary
- 1 Hole Center Set Mounting
- 3 Hole 8" Center Set Mounting Using Cover Plate
- 1 Second Shut Off Delay
- Adjustable Digital Sensing Range: 2"(55mm) - 12"(300mm)
- Automatic Water Flow Shut-Off: 30 Seconds  
(Meets or Exceeds Current CDC Hand Washing Guidelines)
- Operating Water Pressure: 10-125 PSI
- Easy Installation
- ADA Compliant

## The HEALTHFLO<sup>®</sup> Advantage

The HEALTHFLO<sup>®</sup> is a safer and more hygienic hand washing system for healthcare facilities by using Bacterial Growth Limiting Components (BGLC). The patented motor drive mechanism eliminates magnetic solenoids and porous rubber or vinyl diaphragms which can harbor biofilm growth. The water velocity through the HEALTHFLO<sup>®</sup> sensor faucet system is increased to flush it clean after every use, and the triggering assembly cleans itself of debris that would ordinarily cause other mechanisms to weep. The system also eliminates rubber-orifice flow controls that can also harbor bacteria, and it is designed to flow at its specified flow rate regardless of variations in water pressure, without flow controls or outlet devices of any kind. The HEALTHFLO<sup>®</sup> sensor faucet system is available in 1.5gpm and 2.2gpm flow rates.

The unique design of the HEALTHFLO<sup>®</sup> sensor faucet system allows for the use of various power options including battery power, electrical power (with battery back-up), or an environmentally friendly hydro-generator.

## Accessories (Add suffix to model number for accessories)

### Cover Plates

- CP4 Cover Plate for 4" Center Set (6.25" Length)
- CP8 Cover Plate for 8" Center Set (10.25" Length)
- CP8-1 Cover Plate for 8" Center Set (12.25" Length)
- HC Hole Covers (Set of 2)



Warranty  
5 Years



 ADA Compliant

### Alternate Power Options

- HG01 Plug-in Hydro-power Electric Generator
- AD01 Plug-in 6-Volt AC Power Adapter

### Temperature Mixing Valves

- MV Mechanical Mixing Valve (Below Deck)
- TMV Thermostatic Mixing Valve (Below Deck)

For Finish Variations Please Consult Factory

## Architect/Engineer Approval

Job Name	_____
Date	_____
Model Specified	_____
Quantity	_____
Variations Specified	_____
Customer/Wholesaler	_____
Contractor	_____
Architect	_____



# HEALTHFLO<sup>®</sup>

## AUTOMATIC FAUCET SYSTEMS

Model  
AEF-300-SMHF

### Specifications:

Operation:	Automatic (Gear Motor Drive)
Spout:	Solid Brass Spout
Mounting Applications:	1 Hole Center Set
	3 Hole 8" Center Set (using cover plate)
Sensor Type:	Infrared
Battery Type:	Four (4) C-Cell
Battery Life:	400,000 Cycles or 3 Years
Alternate Power (optional):	Plug-in 6-Volt AC Power Adapter
	Plug-in Hydro-power Electric Generator
Working Water Pressure:	10-125 PSI
Supply Inlet Size:	1/2" Supply Inlet
Temperature Control:	None (use TMV to mix hot/cold water)
Pop-Up Drain Rod:	None
Sensor Location:	Base of Spout
Sensor Range Setting:	Digital Push Button
Sensing Range:	2"(55mm) - 12"(300mm)
Shut-Off Delay Time:	1 Second
Automatic Shut-Off Time:	30 Seconds
Low Battery Indicator:	Solid Red Light on Sensor

When the AEF-300-SMHF faucet is installed on a three (3) hole 4" or 8" center set application, a cover plate should be used.



**Cover Plates should be specified separately.**

**CP4** - Cover Plate for 4" (102mm) center set.  
(Actual plate length 6.25" (159mm))

**CP8** - Cover Plate for 8" (204mm) center set.  
(Actual plate length 10.25" (260mm))

**CP8-1** - Cover Plate for 8" (204mm) center set.  
(Actual plate length 12.25" (311mm))

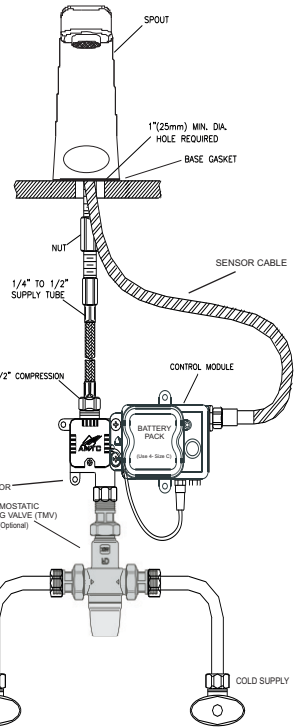

Shown using hot and cold water mixing

### Dimensions:

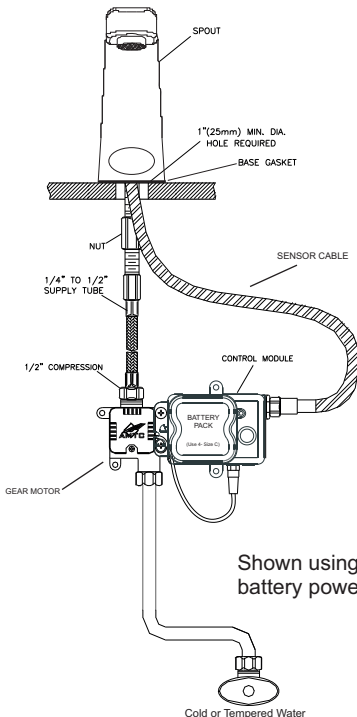
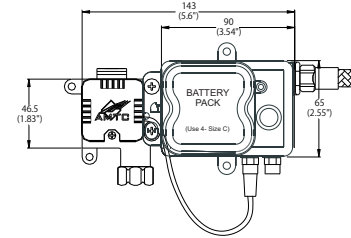
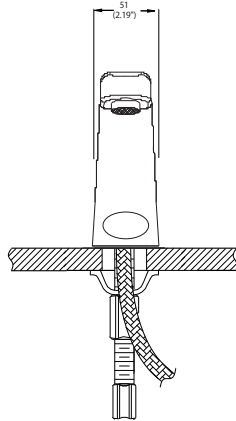
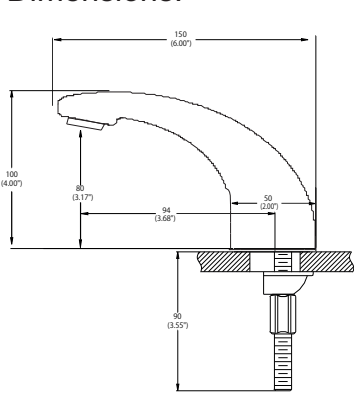

Shown using standard battery power.

Cold or Tempered Water

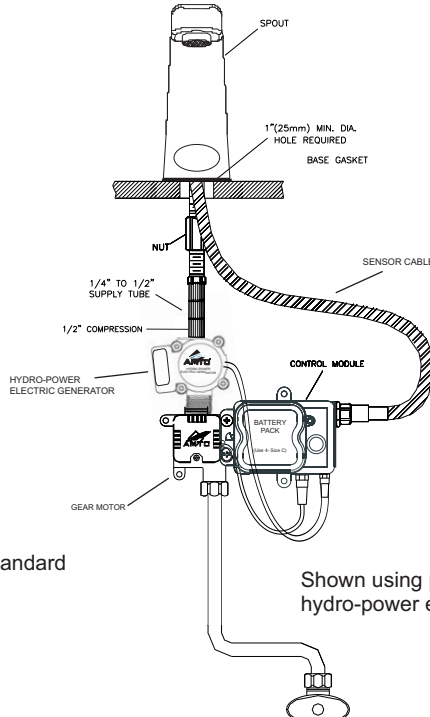

Shown using plug-in hydro-power electric generator.

Cold or Tempered Water

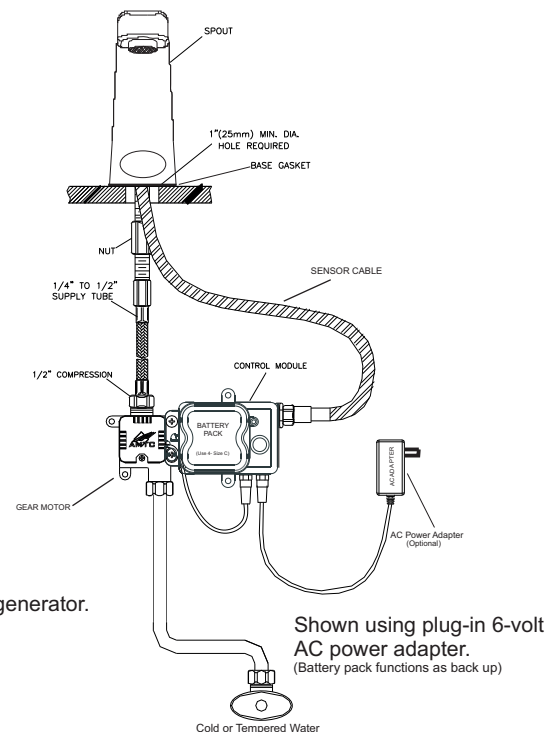

Shown using plug-in 6-volt AC power adapter.  
(Battery pack functions as back up)

Cold or Tempered Water

Advanced Modern Technologies Corporation • 8367 Canoga Avenue • Canoga Park, CA 91304  
Tel: (818) 883-2682 • Toll Free: (800) 874-7822 • Fax: (818) 883-2620 • www.amtccorporation.com