



FIXEDFLO[®]

AUTOMATIC FAUCET SYSTEMS

Model
AEF-300-SMFF



Description

High Efficiency, Non-Adjustable, Sensor Operated, Gear Motor Driven, Chrome Plated Brass Automatic Faucet System For Tempered or Hot/Cold Water Operation

Flow Rate

- 0.35 gpm/1.3 Lpm Spray Head (Cal Green Compliant)
- 0.5 gpm/1.9 Lpm Spray Head

Specifications

- Chrome Plated Solid Brass Spout (Standard)
- Less Than 0.25% Lead Content by Weighted Average
- Patented BRV[®] and Gear Motor Drive
- Hands Free Infrared Sensor Activation
- Powered by Four (4) C-Cell Batteries (Included)
- Easy Battery Replacement - No Water Shut Off Necessary
- Removable Filtering System (Easily Cleaned)
- 1 Hole Center Set Mounting
- 3 Hole 8" Center Set Mounting Using Cover Plate
- 1 Second Shut Off Delay
- Adjustable Digital Sensing Range: 2"(55mm) - 12"(300mm)
- Automatic Water Flow Shut-Off: 10 Seconds
- Operating Water Pressure: 10-125 PSI
- Easy Installation
- ADA Compliant



The FIXEDFLO[®] Advantage

The FIXEDFLO[®] is the first and only high-efficiency faucet (HEF) system providing ultimate water savings through non-adjustable or "fixed" water flow. The FIXEDFLO[®] sensor faucet system does not use a typical diaphragm. Instead a uniquely designed internal water flow mechanism allows the faucet to stream at a pre-set flow rate that cannot be externally altered even by the use or replacement of an aerator. The FIXEDFLO[®] sensor faucet system is available in 0.35gpm and 0.5gpm water flow rates. The FIXEDFLO[®] line is ideal for all public facilities where water conservation is a priority.

The unique design of the FIXEDFLO[®] sensor faucet system allows for the use of various power options including battery power, electrical power (with battery back-up), or an environmentally friendly hydro-generator.

Accessories (Add suffix to model number for accessories)

Cover Plates

- CP4 Cover Plate for 4" Center Set (6.25" Length)
- CP8 Cover Plate for 8" Center Set (10.25" Length)
- CP8-1 Cover Plate for 8" Center Set (12.25" Length)
- HC Hole Covers (Set of 2)

Alternate Power Options

- HG01 Plug-in Hydro-power Electric Generator
- AD01 Plug-in 6-Volt AC Power Adapter

Temperature Mixing Valves

- MV Mechanical Mixing Valve (Below Deck)
- TMV Thermostatic Mixing Valve (Below Deck)

For Finish Variations Please Consult Factory



UPC and Low Lead Compliant

Warranty
5 Years



 ADA Compliant

Architect/Engineer Approval

Job Name	_____
Date	_____
Model Specified	_____
Quantity	_____
Variations Specified	_____
Customer/Wholesaler	_____
Contractor	_____
Architect	_____



FIXEDFLO[®]

AUTOMATIC FAUCET SYSTEMS

Model
AEF-300-SMFF

Specifications:

Operation:	Automatic (Gear Motor Drive)
Spout:	Solid Brass Spout
Mounting Applications:	1 Hole Center Set
	3 Hole 8" Center Set (using cover plate)
Sensor Type:	Infrared
Battery Type:	Four (4) C-Cell
Battery Life:	400,000 Cycles or 3 Years
Alternate Power (optional):	Plug-in 6-Volt AC Power Adapter
	Plug-in Hydro-power Electric Generator
Working Water Pressure:	10-125 PSI
Supply Inlet Size:	1/2" Supply Inlet
Temperature Control:	None (use TMV to mix hot/cold water)
Pop-Up Drain Rod:	None
Sensor Location:	Base of Spout
Sensor Range Setting:	Digital Push Button
Sensing Range:	2"(55mm) - 12"(300mm)
Shut-Off Delay Time:	1 Second
Automatic Shut-Off Time:	10 Seconds
Low Battery Indicator:	Solid Red Light on Sensor

When the AEF-300-SMFF faucet is installed on a three (3) hole 4" or 8" center set application, a cover plate should be used.



Cover Plates should be specified separately.

CP4 - Cover Plate for 4" (102mm) center set.
(Actual plate length 6.25" (159mm))

CP8 - Cover Plate for 8" (204mm) center set.
(Actual plate length 10.25" (260mm))

CP8-1 - Cover Plate for 8" (204mm) center set.
(Actual plate length 12.25" (311mm))

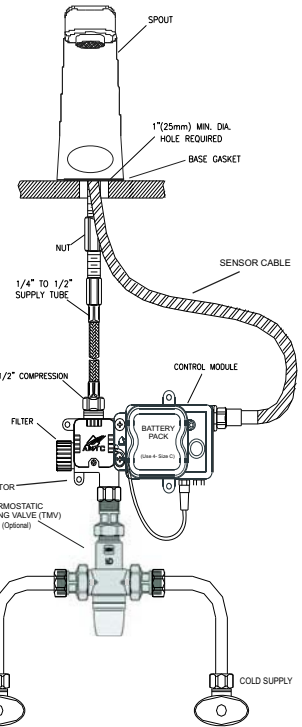

Shown using hot and cold water mixing

Dimensions:

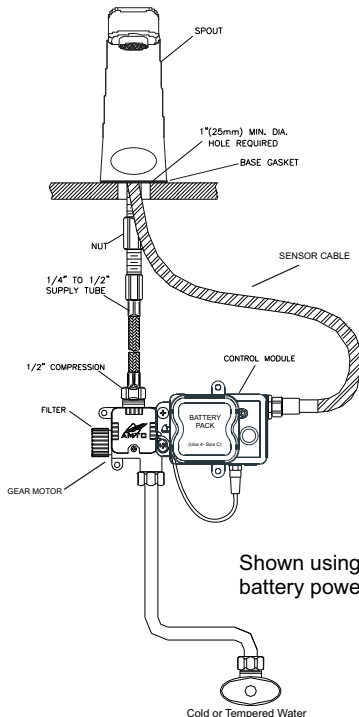
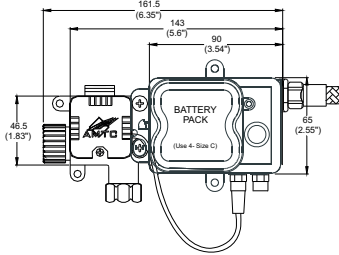
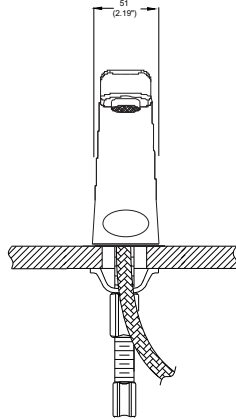
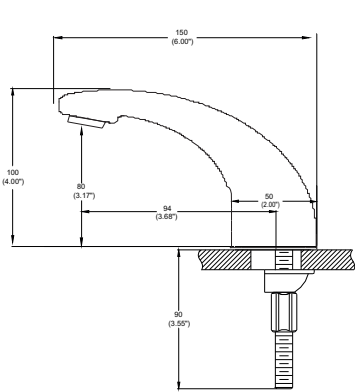

Shown using standard battery power.

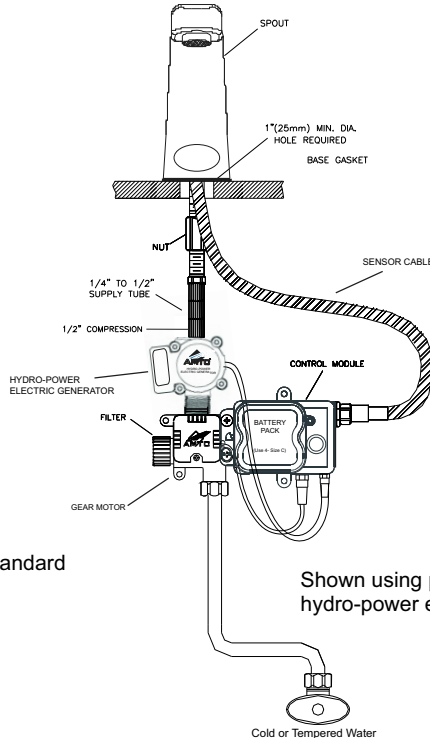

Shown using plug-in hydro-power electric generator.

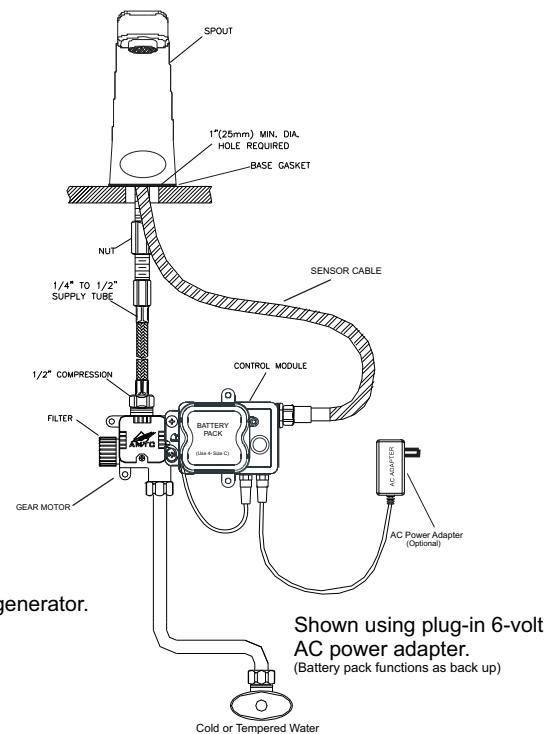

Shown using plug-in 6-volt AC power adapter.
(Battery pack functions as back up)

Advanced Modern Technologies Corporation • 8367 Canoga Avenue • Canoga Park, CA 91304
Tel: (818) 883-2682 • Toll Free: (800) 874-7822 • Fax: (818) 883-2620 • www.amtccorporation.com